

4200-SCS

Semiconductor Characterization System



4200-SPEC Rev. F

1.888.KEITHLEY (U.S. only)

www.keithley.com

KEITHLEY

A GREATER MEASURE OF CONFIDENCE

4200-SCS

- 2 Introduction**
- 3 Configuration Options**
- 5 Hardware Specifications**
- 7 KTE Interactive Software Tools**
 - 7 Microsoft Windows NT
 - 8 The Keithley Interactive Test Environment (KITE)
 - 14 User Libraries (KULT)
 - 18 System Configuration and Diagnostics (KCON)
 - 18 Keithley External Control Interface (KXCI)
- 18 Accessories Supplied**
 - 18 Optional Instrumentation
- 19 Support Options**
 - 19 Calibration Options
 - 19 Repair Options
 - 19 Instrumentation Upgrades
- 20 Embedded PC Policy**
- 20 Optional Accessories**
 - 20 Computer Options
 - 20 Remote PreAmp Mounting Accessories
 - 20 Other Accessories
 - 20 C-V Options
- 20 Warranty Information**
- 21 Switch Matrix Options**
 - 21 Ultra-Low Current/Local Sense Configuration (4200-UL-LS-XX)
 - 22 Ultra-Low Current/Remote Sense Configuration (4200-UL-RS-XX)
 - 23 Low Current/Remote Sense Configuration (4200-LC-RS-XX)
 - 24 General-Purpose Remote Sense Configuration (4200-GP-RS-XX)
- 25 Cabinets and Mounting Accessories**
- 25 Additional Cables and Connectors**
- 26 Front and Rear Panel Photographs**
- 27 PreAmp Mounting and Cabling**
- 28 4200-SCS Accessories**

Semiconductor Characterization System

Introduction

The Model 4200-SCS provides a total system solution for DC characterization and stress-measure/reliability testing of semiconductor devices and test structures. This advanced parameter analyzer provides intuitive and sophisticated capabilities for semiconductor device characterization. The 4200-SCS combines unprecedented measurement speed and accuracy with an embedded Windows NT- or XP-based PC and the Keithley Interactive Test Environment (KITE) to provide a powerful single-box solution.

The Keithley Interactive Test Environment allows users to gain familiarity quickly with tasks such as managing tests and results and generating reports. Sophisticated and simple test sequencing and external instrument drivers simplify performing automated device and wafer testing with combined I-V and C-V measurements.

The 4200-SCS is modular and configurable. The system supports up to eight Source-Measure Units, including up to four high power SMUs with 1A/20W capability. An optional Remote PreAmp extends the resolution of any Source-Measure Unit from 100fA to 0.1fA.

1.888.KEITHLEY (U.S. only)

www.keithley.com

KEITHLEY

A GREATER MEASURE OF CONFIDENCE

4200-SCS

Semiconductor Characterization System

Configuration Options

The 4200-SCS supports many instrument configurations. The standard configuration includes two medium power Source-Measure Units (SMUs) and a Ground Unit.

Standard 4200-SCS Models

4200-SCS/F	Chassis 12.1" flat panel display Two (2) Model 4200-SMU medium power SMUs One (1) Remote Sense Ground Unit LAN, GPIB, RS-232, parallel port, hard disk, floppy disk drive, CD-RW, USB
4200-SCS/C	Chassis Composite Front Bezel (CRT/FPD sold separately, Model 4200-CRT or 4200-FPD-RM) Two (2) Model 4200-SMU medium power SMUs One (1) Remote Sense Ground Unit LAN, GPIB, RS-232, parallel port, hard disk, floppy disk drive, CD-RW, USB

Source-Measure Units

Each system can be configured with up to six additional SMUs, for a total of eight SMUs. Two different SMU models are available: a medium power (100mA, 2W) version (Model 4200-SMU) and a high power (1A, 20W) version (Model 4210-SMU). The system can support up to four high power SMUs. Optional SMUs are installed beginning with the medium power version first, then the high power version.

4200-SCS Source-Measure Units

	Maximum Voltage	Maximum Current	Maximum Power
4200-SMU (medium power)	210V	100mA	2W
4210-SMU (high power)	210V	1A	20W

Remote PreAmp

The low current measurement capabilities of any SMU can be extended by adding an optional Remote PreAmp (Model 4200-PA). The 4200-PA provides 0.1fA resolution by effectively adding five current ranges to either SMU model. The PreAmp module is fully integrated with the system; to the user, the SMU simply appears to have additional measurement resolution available. The Remote PreAmp is shipped installed on the back panel of the 4200-SCS for local operation. This installation allows for standard cabling to a prober, test fixture, or switch matrix. Users can remove the PreAmp from the back panel and place it in a remote location (such as in a light-tight enclosure or on the prober platen) to eliminate measurement problems due to long cables. Platen mounts and triax panel mount accessories are available. Remote PreAmps are installed at the factory in numerical order, i.e., SMU1, SMU2, SMU3... up to the number of PreAmps specified. **Note:** All medium power SMUs must have PreAmps installed before PreAmps can be installed on high power SMUs.

1.888.KEITHLEY (U.S. only)

www.keithley.com

KEITHLEY

A GREATER MEASURE OF CONFIDENCE

Semiconductor Characterization System

Configuration Examples

The 4200-SCS's plug-in chassis design offers exceptional configuration flexibility, as these examples illustrate. Any of these configurations can be specified without a flat panel display by substituting the 4200-SCS/C for the 4200-SCS/F. However, an external SVGA monitor is required to operate the 4200-SCS/C.

Base Configuration with Ultra-Low Current

Configuration:	One (1) Model 4200-SCS/F One (1) Model 4200-PA Remote PreAmp module
Description:	Includes 4200-SCS with flat panel display, two 4200-SMU medium power SMUs, one 4200-PA remote PreAmp factory installed on SMU1 and a ground unit. Provides 3-terminal device characterization using the built-in ground unit with 0.1fA sensitivity on SMU1.

General-Purpose Configuration (comparable to Agilent 4155)

Configuration:	One (1) Model 4200-SCS/F Two (2) Model 4200-SMUs
Description:	Includes 4200-SCS with flat panel display, four 4200-SMU medium power SMUs and a ground unit with 0.1pA sensitivity.

Ultra-Low Current Configuration (comparable to Agilent 4156)

Configuration:	One (1) Model 4200-SCS/F Two (2) Model 4200-SMUs Four (4) Model 4200-PA Remote PreAmp modules
Description:	Includes four medium power SMUs, four Remote PreAmps factory installed on SMUs 1-4, and a ground unit. This system provides 0.1fA sensitivity on all four SMUs. An excellent configuration for standard parameter analysis plus ultra-low current measurement of MOSFET off current or dielectric leakage currents.

Ultra-Low Current, High Power Configuration

Configuration:	One (1) Model 4200-SCS/F Two (2) Model 4200-SMUs One (1) Model 4210-SMU Five (5) Model 4200-PA Remote PreAmp modules
Description:	Includes four medium power SMUs, one high power SMU, five Remote PreAmps factory installed on SMUs 1-5, and a ground unit. Provides a five SMU system with 0.1fA sensitivity on all SMUs and 1A capability on SMU5.

Maximum Configuration

Configuration:	One (1) Model 4200-SCS/F Two (2) Model 4200-SMUs Four (4) Model 4210-SMUs Eight (8) Model 4200-PA Remote PreAmp modules
Description:	Includes four medium power SMUs, four high power SMUs, eight Remote PreAmps factory installed on SMUs 1-8 and a ground unit. Provides an eight SMU system with 0.1fA sensitivity on all eight SMUs and 1A capability on four channels.

1.888.KEITHLEY (U.S. only)

www.keithley.com

KEITHLEY

A GREATER MEASURE OF CONFIDENCE

Hardware Specifications

CURRENT SPECIFICATIONS

	Current Range ¹	Max. Voltage	Measure		Source	
			Resolution ³	Accuracy ±(% rdg + amps)	Resolution ³	Accuracy ±(% rdg + amps)
4210-SMU ² High Power SMU	1 A	21 V	1 μA	0.100 % + 200 μA	50 μA	0.100 % + 350 μA
	100 mA	210 V	100 nA	0.045 % + 3 μA	5 μA	0.050 % + 15 μA
	100 mA	21 V	100 nA	0.045 % + 3 μA	5 μA	0.050 % + 15 μA
	10 mA	210 V	10 nA	0.037 % + 300 nA	500 nA	0.042 % + 1.5 μA
4200-SMU ² Medium Power SMU	1 mA	210 V	1 nA	0.035 % + 30 nA	50 nA	0.040 % + 150 nA
	100 μA	210 V	100 pA	0.033 % + 3 nA	5 nA	0.038 % + 15 nA
	10 μA	210 V	10 pA	0.050 % + 600 pA	500 pA	0.060 % + 1.5 nA
	1 μA	210 V	1 pA	0.050 % + 100 pA	50 pA	0.060 % + 200 pA
4200-SMU and 4210-SMU with optional 4200-PA PreAmp	100 nA	210 V	100 fA	0.050 % + 30 pA	5 pA	0.060 % + 30 pA
	10 nA	210 V	10 fA	0.050 % + 1 pA	500 fA	0.060 % + 3 pA
	1 nA	210 V	3 fA	0.050 % + 100 fA	50 fA	0.060 % + 300 fA
	100 pA	210 V	1 fA	0.100 % + 30 fA	15 fA	0.100 % + 80 fA
	10 pA	210 V	0.3 fA	0.500 % + 15 fA	5 fA	0.500 % + 50 fA
	1 pA	210 V	100 aA	1.000 % + 10 fA	1.5 fA	1.000 % + 40 fA

VOLTAGE COMPLIANCE: Bipolar limits set with a single value between full scale and 10% of selected voltage range.

VOLTAGE SPECIFICATIONS

Voltage Range ¹	Max. Current		Measure		Source	
	4200-SMU	4210-SMU	Resolution ³	Accuracy ±(% rdg + volts)	Resolution ³	Accuracy ±(% rdg + volts)
200 V ⁺	10.5 mA	105 mA	200 μV	0.015 % + 3 mV	5 mV	0.02% + 15 mV
20 V	105 mA	1.05 A	20 μV	0.01 % + 1 mV	500 μV	0.02% + 1.5 mV
2 V	105 mA	1.05 A	2 μV	0.012 % + 150 μV	50 μV	0.02% + 300 μV
200 mV	105 mA	1.05 A	1 μV	0.012 % + 100 μV	5 μV	0.02% + 150 μV

CURRENT COMPLIANCE: Bipolar limits set with a single value between full scale and 10% of selected current range.

Supplemental Information

Supplemental information is not warranted, but provides useful information about the 4200-SMU, 4210-SMU, and 4200-PA.

COMPLIANCE ACCURACY:

Voltage compliance equals the voltage source specifications.
Current compliance equals the current source specifications.

OVERSHOOT: <0.1% typical.

Voltage: Full scale step, resistive load, and 10mA range.
Current: 1mA step, $R_L = 10k\Omega$, 20V range.

RANGE CHANGE TRANSIENT:

Voltage Ranging: <200mV
Current Ranging: <200mV

ACCURACY SPECIFICATIONS: Accuracy specifications are multiplied by one of the following factors, depending upon the ambient temperature and humidity.

Temperature	% Relative Humidity	
	5–60	60–80
10°–18°C	×3	×3
18°–28°C	×1	×3
28°–40°C	×3	×5

REMOTE SENSE:

<10Ω in series with FORCE terminal not to exceed a 5V difference between FORCE and SENSE terminals.
±30V maximum between COMMON and SENSE LO.

MAXIMUM LOAD CAPACITANCE: 10nF

MAXIMUM GUARD OFFSET VOLTAGE: 3mV from FORCE.

GUARD OUTPUT IMPEDANCE: 100kΩ.

MAXIMUM GUARD CAPACITANCE: 1500pF.

MAXIMUM SHIELD CAPACITANCE: 3300pF.

4200-SMU and 4210-SMU SHUNT RESISTANCE (FORCE to COMMON): >10¹²Ω (100nA–1μA ranges).

4200-PA SHUNT RESISTANCE (FORCE to COMMON): >10¹⁶Ω (1pA and 10pA ranges), >10¹³Ω (100pA–100nA ranges).

OUTPUT TERMINAL CONNECTION: Dual triaxial connectors for 4200-PA, dual mini-triaxial connectors for 4200-SMU and 4210-SMU.

NOISE CHARACTERISTICS (typical):

Voltage Source (rms): 0.01% of output range.
Current Source (rms): 0.1% of output range.
Voltage Measure (p-p): 0.02% of measurement range.
Current Measure (p-p): 0.2% of measurement range.

MAXIMUM SLEW RATE: 0.2V/μs.

1.888.KEITHLEY (U.S. only)

www.keithley.com



A GREATER MEASURE OF CONFIDENCE

4200-SCS

Semiconductor Characterization System

Additional Specifications

MAX. OUTPUT POWER: 22 watts for 4210-SMU and 2.2 watts for 4200-SMU (both are four-quadrant source/sink operation).

DC FLOATING VOLTAGE: COMMON can be floated ± 32 volts from chassis ground.

VOLTAGE MONITOR (SMU in VMU mode):

Voltage Range	Measure Resolution	Measure Accuracy \pm (%rdg + volts)
200 V	200 μ V	0.015% + 3 mV
20 V	20 μ V	0.01% + 1 mV
2 V	2 μ V	0.012% + 110 μ V
200 mV	1 μ V	0.012% + 80 μ V

INPUT IMPEDANCE: $>10^{13}\Omega$.

INPUT LEAKAGE CURRENT: <30 pA.

MEASUREMENT NOISE: 0.02% of measurement range (rms).

DIFFERENTIAL VOLTAGE MONITOR:

Differential Voltage Monitor is available by measuring with two SMUs in VMU mode, or by using the low sense terminal provided with each SMU.

GROUND UNIT

Voltage error when using the ground unit is included in the 4200-SMU, 4210-SMU, and 4200-PA specifications. No additional errors are introduced when using the ground unit.

OUTPUT TERMINAL CONNECTION: Dual triaxial, 5-way binding post.

MAXIMUM CURRENT: 2.6A using dual triaxial connection; 4.4A using 5-way binding posts.

LOAD CAPACITANCE: No limit.

CABLE RESISTANCE: FORCE $\leq 1\Omega$, SENSE $\leq 10\Omega$.

SPECIFICATION CONDITIONS

Specifications are the performance standards against which the 4200-SMU, 4210-SMU, and 4200-PA are tested. The measurement and source accuracy are specified at the termination of the supplied cables.

- 23°C $\pm 5^\circ$ C, within 1 year of calibration, RH between 5% and 60%, after 30 minutes of warm-up.
- Speed set to NORMAL.
- Guarded Kelvin connection.
- $\pm 1^\circ$ C and 24 hours from ACAL.

GENERAL

TEMPERATURE RANGE

Operating: $+10^\circ$ to $+40^\circ$ C.

Storage: -15° to $+60^\circ$ C.

HUMIDITY RANGE

Operating: 5% to 80% RH, non-condensing.

Storage: 5% to 90% RH, non-condensing.

ALTITUDE

Operating: 0 to 2000m.

Storage: 0 to 4600m.

POWER REQUIREMENTS: 100V to 240V, 50 to 60Hz.

MAXIMUM VA: 500VA.

REGULATORY COMPLIANCE:

Safety: Low Voltage Directive 73/23/EEC.

EMC: Directive 89/336/EEC.

DIMENSIONS: 43.6cm wide \times 22.3cm high \times 56.5cm deep (17 $\frac{7}{8}$ in \times 8 $\frac{3}{4}$ in \times 22 $\frac{1}{4}$ in).

WEIGHT (approx.): 29.7kg (65.5 lbs) for typical configuration of four SMUs.

I/O PORTS: SVGA, Printer, RS-232, GPIB, Ethernet, Mouse, Keyboard.

ACCESSORIES SUPPLIED:

4200-MTRX-2	Ultra Low Noise SMU Triax Cable (2 supplied for each SMU), 2m (6.6 ft). Not included with SMUs configured with a 4200-PA PreAmp.
4200-TRX-2	Ultra Low Noise PreAmp Triax Cables, 2m (6.6 ft). 2 supplied for Ground Unit. 2 supplied in replacement of 4200-MTRX-2 cables for each SMU configured with a 4200-PA.
4200-RPC-2	Remote PreAmp Cable (1 supplied for each PreAmp), 2m (6.6 ft).
236-ILC-3	Interlock Cable, 3m (10 ft)
Line Cord	NEMA 5-15P for 100–115VAC. CEE 7/7 (Continental European) for 240VAC.

Keyboard and Pointing Device

User Manual

NOTES

- 1 All ranges extend to 105% of full scale.
- 2 Specifications apply on these ranges with or without a 4200-PA.
- 3 Specified resolution is limited by fundamental noise limits. Measured resolution is 6 $\frac{1}{2}$ digits on each range. Source resolution is 4 $\frac{1}{2}$ digits on each range.
- 4 Interlock must be engaged to use the 200V range.

1.888.KEITHLEY (U.S. only)

www.keithley.com

KEITHLEY

A GREATER MEASURE OF CONFIDENCE

KTE Interactive Software Tools

KTE Interactive includes four software tools for operating and maintaining the 4200-SCS:

- Keithley Interactive Test Environment (KITE)—The 4200-SCS device characterization application
- Keithley User Library Tool (KULT)—Allows test engineers to integrate custom algorithms into KITE using 4200-SCS or external instruments.
- Keithley Configuration Utility (KCON)—Allows test engineers to define the configuration of GPIB instruments, switch matrices, and analytical probers connected to the 4200-SCS. It also provides system diagnostics functions.
- Keithley External Control Interface (KXCI)—The 4200-SCS application for controlling the 4200-SCS from an external computer via the GPIB bus.

Microsoft Windows NT/XP

Windows NT/XP Operating System

The operating system is a standard distribution of Microsoft Windows NT or XP. Newer systems are configured with the Windows XP Professional Operating System. Upgrades are available for older systems. Contact the Keithley factory for supported versions and service packs.

Security and Administration Management

A third-party administration package is installed and configured on each system. This package provides lab supervisors a simple interface for managing system security. The 4200-SCS is factory configured with two accounts. The administrator account allows access to all system resources without limitation. The administrator account has complete access to the security settings of the user account, which is designed for day-to-day use.

Data Storage

Fixed disk

Internal high capacity fixed disk drive stores the operating system, application programs, and data files.

1.44MB Flexible Diskette Drive

Standard 3.5 inch, 1.44MB flexible diskette drive.

CD-RW Drive

Standard CD read-write drive is provided for data storage and retrieval.

Connectivity

The 4200-SCS includes a 10/100BASET Ethernet interface with software drivers installed.

Semiconductor Characterization System

The Keithley Interactive Test Environment (KITE)

The Keithley Interactive Test Environment (KITE) is the Model 4200-SCS Windows device characterization application. It provides advanced test definition, parameter analysis and graphing, and automation capabilities required for modern semiconductor characterization.

KITE Projects

A project is a collection of related tests, organized in a hierarchy that parallels the physical layout of the devices on a wafer. KITE operates on projects using an interface called the project navigator. The project navigator simplifies organizing test files, test execution, and test sequencing.

The project navigator organizes tests into a logical hierarchy presented in a browser style format. This structure allows users to define projects around wafer testing:

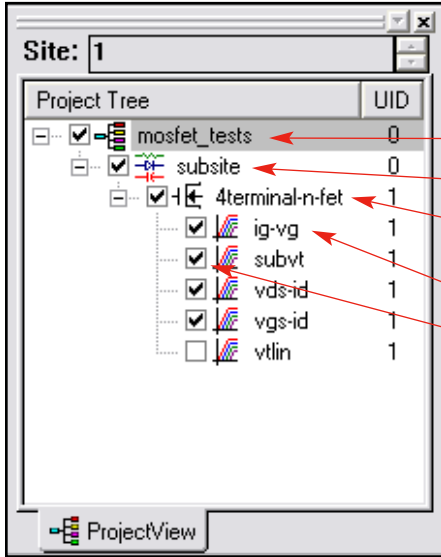

The project level organizes subsites and controls wafer looping execution.

The subsite level organizes devices and controls subsite test sequencing.

The device level organizes test modules, manages test module libraries and controls device test sequencing.

The test module level performs tests, analyzes data, and plots results.

Selectable checkboxes allow enabling/disabling individual tests/plans.

Test Modules

Within KITE, two types of test modules are provided to capture the test input parameters, data analysis, and plot setting for data. “Interactive Test Modules” provide a point-and-click interface for defining test input parameters and controlling the 4200-SCS SMUs. “User Test Modules” provide a fill-in-the-blank interface to either factory-provided or user-written C language subroutines. These subroutines can control internal 4200-SCS instruments and/or external instruments and systems through the RS-232 or GPIB interface. This dual approach provides an extendable test environment that gives the users the same capabilities for data analysis, plotting, and output and automation, whether the instrument used is part of the base system or an external instrument. It also offers users the flexibility to write complex test algorithms for control of either internal or external instruments.

Definition Tab—Interactive Test Module

The Definition Tab of an ITM provides a point-and-click interface for setting test input parameters that control the 4200-SCS SMUs and defining parameter extractions. Two modes are available:

Sweep Mode

Forcing Functions:	Common, Voltage Bias, Current Bias (VMU), Voltage Sweep, Current Sweep, Voltage Step, Current Step, Voltage List Sweep, Current List Sweep.
--------------------	---

Measuring Functions:	Measure Current or Programmed Current, Measure Voltage or Programmed Voltage.
----------------------	---

Fast, Normal, Quiet, and Custom Integration Times

Measure voltage, current or both on each sweep point, regardless of forcing function.

Sampling Mode

Linear sampling of up to 4096 points. Sampling period is programmable from 1ms to 1000s. Additional hold delay before first sample of up to 1000s.

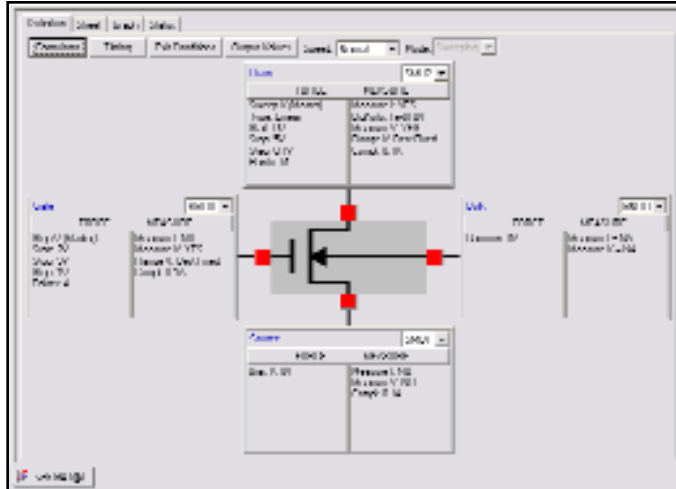

Interactive Test Modules (ITM) are built from three different major functions: Definition, Sheet and Graph. The Definition Tab allows the operator to define a sweep or sampling mode test using a graphical approach. The Sheet Tab stores acquired data and provides an Excel®-like workbook for viewing and analyzing test results. The Graph Tab provides a full-featured data plotting tool capable of producing report-ready graphs. The Status Tab reports any errors that would interfere with test execution.

Definition Tab—User Test Module

The Definition Tab of a UTM presents users a tabular fill-in-the-blank interface for entering input parameters to call a C language subroutine. UTMs provide the ability to control internal SMUs and GPIB and RS-232 devices. This screen allows the user to select a user library, a subroutine module, and then enter the desired input parameters. Test results are returned to the Sheet Tab for viewing and analysis.

Two methods of parameter extraction are available. The Formulater provides automated line fits and parameter extraction. A spreadsheet offers standard spreadsheet analysis tools.

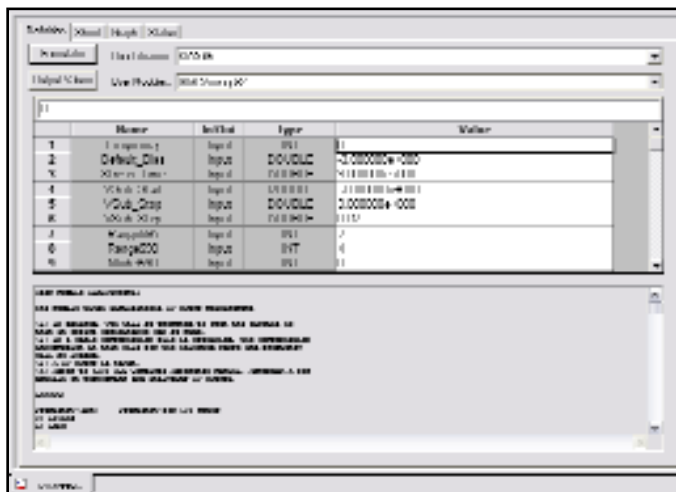

The User Test Module (UTM) has virtually identical functionality as the ITM. However, users enter input parameters for subroutine calls in a tabular interface in the UTM's Definition Tab.

Semiconductor Characterization System

Formulator functions

The Formulator performs data transformations for performing parameter analysis and line fits. The Formulator supports the following functions:

- *Mathematical Functions*

Addition (+), subtraction (-), division (/), multiplication (*), exponent (^), absolute value (ABS), value at an index position (AT), Average (AVG), moving average (MAVG), conditional computation (COND), derivative (DELTA), differential coefficient (DIFF), exponential (EXP), square root (SQRT), natural logarithm (LN), logarithm (LOG), integral (INTG)

- *Line Fits and Parameter Extraction Functions*

Exponential line fit (EXPFIT), coefficient a (EXPFITA), coefficient b (EXPFITB)

Linear Fit (LINFIT), linear slope (LINFITSLP), x intercept (LINFITXINT), y intercept (LINFITYINT)

Logarithmic line fit (LOGFIT), coefficient a (LOGFITA), coefficient b (LOGFITB)

Linear Regression line fit (REGFIT), slope (REGFITSLP), x intercept (REGFITXINT), y intercept (REGFITYINT)

Tangent line fit (TANFIT), slope (TANFITSLP), x intercept (TANFITXINT), y intercept (TANFITYINT)

Maximum value (MAX), minimum value (MIN)

- *Search Functions*

Find Down (FINDD), Find Up (FINDU)

Maximum position (MAXPOS), minimum position (MINPOS)

First Position (FIRSTPOS), Last Position (LASTPOS)

Sub Array (subarray)

Formulator Constants

The Formulator supports user-supplied constants for use in parameter extractions. These constants are factory installed:

$$\text{PI} = 3.14159 \text{ rad}$$

$$\text{K} = 1.38065 \times 10^{-23} \text{ J/K}$$

$$\text{Q} = 1.60218 \times 10^{-19} \text{ C}$$

$$\text{M}_0 = 9.10938 \times 10^{-31} \text{ kg}$$

$$\text{E}_v = 1.60218 \times 10^{-19} \text{ J}$$

$$\text{U}_0 = 1.25664 \times 10^{-6} \text{ N/A}^2$$

$$\text{E}_0 = 8.85419 \times 10^{-12} \text{ F/m}$$

$$\text{H} = 6.62607 \times 10^{-34} \text{ J-s}$$

$$\text{C} = 2.99792 \times 10^8 \text{ m/s}$$

$$\text{KT/Q} = 0.02568 \text{ V}$$

Sheet Tab—Data Viewing and Analysis

The Sheet Tab of a test module captures data from a test execution and allows calculations in a spreadsheet. The Sheet Tab operates like an Excel workbook with the following spreadsheets: the Data sheet, the Calc sheet, the Settings sheet, and Append sheets.

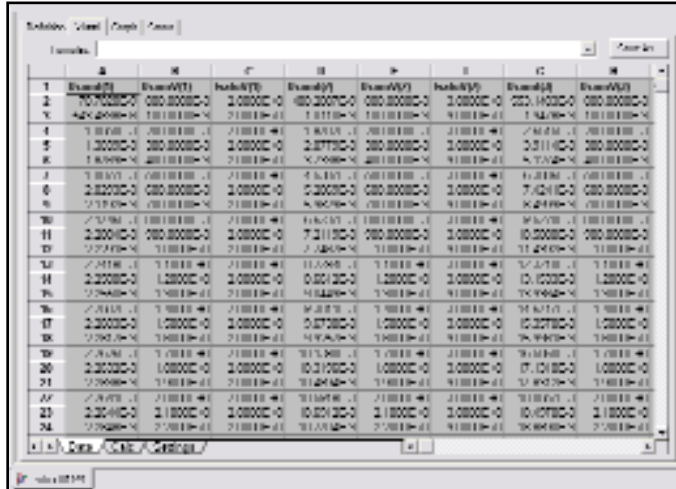

Data Sheet

The Data sheet displays test results in real time. It is read-only so that results cannot be modified.

Calc Sheet

A spreadsheet that operates much like a standard Microsoft Excel® spreadsheet is available for computation with each test. The spreadsheet tool supports these functions:

Functions in the KITE Calc sheet

ABS	ACOS	ACOSH	ASIN	ASINH
ATAN	ATAN2	ATANH	AVERAGE	COS
COSH	EXP	FIXED	IF	LN
LOG	LOG10	LOOKUP	MATCH	MAX
MIN	NOW	PI	PRODUCT	ROUND
SIGN	SIN	SINH	SQRT	STDEVP
SUM	SUMSQ	TAN	TANH	VARP

Settings Sheet

The Settings sheet stores the test setup so that when the Sheet tab is exported as a workbook, users can refer to the test configuration.

Append Sheet

Append sheets store test results when the Append button is clicked. Data in Append sheets is automatically plotted on the graph. Test modules support up to twenty Append sheets.

Semiconductor Characterization System

Graph Tab—Plotting

The Graph Tab is a full-featured plotting tool for creating report-ready graphs. It allows real-time XY plotting of acquired and extracted data with one or two Y axes.

- Linear, Semilog, and Log/Log graphs.
- Real-time auto scaling, end of test auto scaling, or manual scaling.
- Six cursors with XY readout.
- Graphical line fitting.
- Plot overlay of multiple test executions.
- Four data variable readouts.
- User-formatted comment box, title, and axis labels.

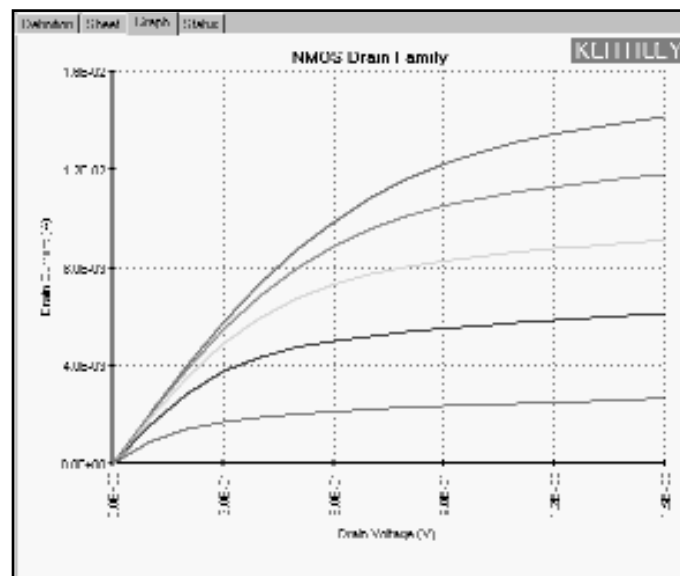

Output

Files

- Sheet tab test results can be saved as a Microsoft Excel Workbook or delimited ASCII text file.
- Plots can be saved as bit map image (.bmp), JPEG (.jpg), or TIFF (.tif) files.

Display

- Flat Panel: 800 by 600 resolution.
- External SVGA: 1024 by 768 or 800 by 600 resolution.

Printers

- A generic printer driver is factory installed using standard Windows NT printer support.

1.888.KEITHLEY (U.S. only)

www.keithley.com

KEITHLEY

A GREATER MEASURE OF CONFIDENCE

Example Projects

The 4200-SCS includes the following KITE projects to facilitate rapid startup and provide examples for common semiconductor lab applications.

1. **DEFAULT**—The default project includes standard tests for MOSFETs, BIPOLAR transistors, resistors, and diodes. This project helps users to get started quickly.
2. **IVSWITCH**—The ivswitch project integrates control of a Keithley Model 707 or Model 708 external switch matrix with device testing.
3. **IVCVSWITCH**—The ivcvswitch project integrates control of the Keithley Model 590 C-V Analyzer, the HP 4284 and a Keithley switch matrix to configure a combined I-V/C-V characterization station. This project includes extractions of High Frequency C-V parameters for both the Agilent 4284 and Keithley 590 including High Frequency C-V and G or R vs. V with extraction of Oxide Capacitance, Effective Oxide Charge Density, Oxide Thickness, Series Resistance and capacitance adjustment, Doping Profile, Depletion Length, Flatband C and V, Threshold Voltage, Bulk Doping, Metal-Semiconductor Work Function, Debye Length, Bulk Potential and Average Doping; Pulsed High-Frequency C-V and Capacitance vs. Time.
4. **IVPGSWITCH**—The ivpgswitch project integrates an external pulse generator and performs a stress-measure sequence.
5. **PROBESITES**—The probesites project illustrates how KITE controls semi-automatic probe stations for automated probing of one subsite per site on a single wafer.
6. **PROBESUBSITES**—The probesubsites project illustrates how KITE controls semi-automatic probe stations when testing multiple subsites per site on a single wafer.
7. **SIMCV**—The simcv project provides routines for simultaneous C-V measurement using the Keithley System 82. Typical MOS device parameters, such as doping profile, flat band voltage, threshold voltage, interface trap density, and band bending, are extracted.
8. **STVS**—The stvs project uses the Keithley System 82 to perform an STVS (Simultaneous Triangular Voltage Sweep) measurement at high temperature. Mobile ion density is extracted.
9. **LIFETIME**—The lifetime project performs high frequency C-t measurements using the Keithley System 82 on MOS capacitors. The minority carrier recombination lifetime and surface velocity are extracted using a Zerbst Plot.
10. **HCI_1_DUT**—This is a Hot Carrier Injection (HCI) project on one four-terminal N-MOSFET. No switch matrix is involved in the measurement. Parameters monitored between two successive stresses include I_{doff} , I_{don} , I_g , V_p , and G_m . Those parameters are measured on both forward (normal operation condition) and reverse (reverse source and drain bias) conditions. If only a subset of these parameters is needed, it's possible to deselect the test(s) that include the unwanted parametric measurements.
11. **HCI_4_DUT**—This is a Hot Carrier Injection (HCI) project on two four-terminal N-MOSFETs and two four-terminal p-MOSFETs with a switch matrix. Before running the project, the switch matrix and correct pin assignment should be configured in the Keithley Configuration Utility (KCON). Parameters monitored between two successive stresses include I_{doff} , I_{don} , I_g , V_p , and G_m . Those parameters are measured on both forward (normal operation condition) and reverse (reverse source and drain bias) conditions. If only a subset of these parameters is needed, it's possible to deselect the test(s) that include the unwanted parametric measurements. Also, if less than four devices are tested, it's possible to deselect the unwanted device plan in the project tree.
12. **NBTI_1_DUT**—This is a Negative Bias Temperature Instability (NBTI) project on one four-terminal P-MOSFET. Parameters monitored between two successive stresses include I_{doff} , I_{don} , I_g , V_p , and G_m . If only a subset of these parameters is needed, it's possible to deselect the test(s) that include the unwanted parametric measurements.
13. **EM_const_I**—In this electromigration project, first, the hotchuck is raised to the desired high temperature. Then, the resistance of the metal line is measured before it is stressed (using Kelvin connection). Then, constant current is forced to stress the device. During the stress, the resistance of the

1.888.KEITHLEY (U.S. only)

www.keithley.com

KEITHLEY

A GREATER MEASURE OF CONFIDENCE

Semiconductor Characterization System

metal line is measured. If the degradation of the metal line exceeds the design limit or voltage compliance is reached, the project will exit.

14. Q_{BD} —This charge-to-breakdown project consists of two Q_{BD} tests on gate dielectrics (V-Ramp and J-Ramp). Those two tests follow JEDEC Standard 35-A. An additional test performs an I-V measurement under normal work conditions to obtain input parameters for the V-Ramp and J-Ramp tests.

Automation

Test Sequencing

The Keithley Interactive Test Environment (KITE) provides “point and click” test sequencing on a device, a group of devices (subsite, module, or test element group), or a user-programmable number of probe sites on a wafer.

Prober Control

Keithley provides integrated prober control for supported analytical probes when test sequencing is executed on a user-programmable number of probe sites on a wafer. Contact the factory for a list of supported analytical probes. A “manual” prober mode prompts the operator to perform prober operations during the test sequence.

Supported Probers

Manual Prober

Use the manual prober driver to test without utilizing automatic prober functionality. Manual prober replaces all computer control of the prober with that of the operator. At each prober command, a dialog box will appear, instructing the operator what operation is required.

Fake Prober

The Fake prober is useful when prober actions are not desired, such as when debugging, without having to remove prober commands from a sequence.

Cascade Microtech Summit™ 12K Series, verified with Nucleus UI Version 2.0

Karl Suss Model PA-200, verified with Wafermap for ProberBench NT Version 3.1, NI-GPIB Driver for ProberBench NT Version 3.10, PBR232 Interface for ProberBench NT Version 3.00, Navigator for ProberBench NT Version 3.1, Remote Communicator for ProberBench NT Version 3.00

MicroManipulator 8860 Prober, verified with pcBridge Version 2.0.2, pcLaunch Version 2.0.9, pcIndie Version 2.0.7, pcWafer Version 2.0.8, pcNav Version 2.0.8, pcRouter Version 2.0.9

Keithley User Library Tool (KULT)

The Keithley User Library Tool supports creating and integrating C-language subroutine libraries with the test environment. User library modules are accessed in KITE through User Test Modules. Factory supplied libraries provide up and running capability for supported instruments. Users can edit and compile subroutines, then integrate libraries of subroutines with KITE, allowing the 4200-SCS to control an entire test rack from a single user interface. KULT is derived from the Keithley S600 and S400 Series Parametric Test Systems. This simplifies migration of test libraries between the 4200-SCS and Keithley parametric test systems.

Standard User Libraries

The 4200-SCS includes the following useful subroutine libraries, which provide “out of the box” integration and control of Keithley switch matrix systems and other common device characterization equipment. Users access these libraries using the UTM definition tab described on page 9.

parlib

The *parlib* user library is used for extracting device parameters on bipolar and MOSFET transistors. Extracted parameters include Beta, resistance, threshold voltage, and V_{ds-id} sweeps and V_{gs-id} sweeps for MOSFETs.

1.888.KEITHLEY (U.S. only)

www.keithley.com

KEITHLEY

A GREATER MEASURE OF CONFIDENCE

wrlib

The wrlib user library includes routines for performing charge-to-breakdown tests (Q_{BD}) on gate dielectrics. Included modules are qbd_rampv (V-Ramp method) and qbd_rampj (J-Ramp method).

hp4294ulib

The hp4294ulib user library performs capacitance measurements, C-V sweeps, and frequency sweeps using the Hewlett-Packard (Agilent) 4294 LCR meter. This library also includes calibration routines to perform phase, open, short, and load calibrations.

botchuck_triotek

The hotchuck_triotek user library controls Triotek hotchucks. This library will set the target temperature and wait until the target is reached before exiting.

matrixulib

The matrixulib user library connects instrument terminals to output pins using a Keithley 707A or 708A switch system when configured as a general-purpose (Model 4200-GP-RS-XX), low current (Model 4200-LC-LS-XX) or ultra-low current matrix (Model 4200-UL-RS-XX or Model 4200-UL-LS-XX).

ki590ulib

The ki590ulib user library performs 100kHz or 1MHz capacitance measurements, C-V sweeps, C-V pulse sweeps, C-t sweeps, and cable compensation for the Keithley Model 590 C-V Analyzer.

hp4284ulib

The hp4284ulib user library performs capacitance measurements and C-V sweeps using the Hewlett-Packard 4284 LCR meter.

hp8110ulib

The hp8110ulib performs initialization, setup, and triggering for the Hewlett-Packard HP8110 (or 81110) pulse generator.

ki42xxulib

The ki42xxulib user library provides an example subroutine for performing a MOSFET ON resistance (R_{ON}) test routine using the 4200-SCS LPTLIB interface. (See the next section for more information on the LPTLIB interface.)

ki82ulib

The ki82ulib performs simultaneous C-V, C-t, and Q/t measurements and cable compensation for the Keithley System 82 Simultaneous C-V System.

ki595ulib

The ki595ulib performs Q/t sweeps and C-V sweeps using the Keithley Model 595 Quasistatic C-V Meter.

PRBGEN

The PRBGEN user library provides test modules to initialize the prober driver, move to the next site or subsite in the prober's wafer map, make or break contact between the probes and the wafer, and obtain the X position and Y position of the prober. Contact the factory for supported probers.

winulib

The winulib user library provides user interface routines for operator prompting and input.

C language

Microsoft Visual C++ Standard Edition provides the compiler for the Keithley User Library Tool. Users can develop test subroutine libraries using the full capabilities of C-language programming.

LPTLIB Control

The LPTLIB provides an application programming interface for developing C-language test routines that control 4200-SMUs and supported external instruments and switches. This simple connect/source/measure approach eliminates the need for low-level programming and allows the user to focus on creating new test routines quickly. The 4200-SCS LPTLIB is derived from the Keithley S600 series and S400 series parametric test systems to simplify migration of test routines between the 4200-SCS and Keithley parametric test systems.

1.888.KEITHLEY (U.S. only)

www.keithley.com

KEITHLEY

A GREATER MEASURE OF CONFIDENCE

Semiconductor Characterization System

Table 1. 4200-SCS LPTLIB functions

GROUP	FUNCTION CALL	
Instrument	devclr	(Device clear)
	devint	(Device initialize)
Matrix	addcon	(Add connection)
	clrcon	(Clear connection)
	conpin	(Connect pin)
	conpth	(Connect path)
	delcon	(Delete connection)
Ranging	lorangeX	(Define lowest range. X = i, v)
	rangeX	(Set active range. X = i, v)
	setauto	(Re-enable autorange. RangeX automatically disables autorange)
Sourcing	forceX	(Force i or v)
	limitX	(Set the i or v limit/compliance)
	mpulse	(Generate voltage pulse and measure the current)
	pulseX	(Generate a pulse. X = i, v)
Measuring	avgX	(Make multiple measurements and average them. Return the result. X = i, v)
	bmeasX	(Make a block of measurements and return the results. X = i, v)
	imeast	(Measure the timer immediately)
	intgX	(Integrate. Measure i or v over a integer number of power line cycles.)
	measX	(Measure. X = i, v, t)
Combination	asweepX	(Array sweep. X = i, v)
	bsweepX	(Linear breakdown sweep. X = i, v)
	clrscn	(Clear the scan table)
	clrtrg	(Clear the active trigger condition)
	rtfary	(Return the FORCE array)
	savgX	(Average measurements for each point in a sweep. X = i, v)
	scnmeas	(Make measurements simultaneously on multiple instruments)
	searchX	(Binary search measurement. X = i, v)
	sintgX	(Sweep integrate. X = i, v)
	smeasX	(Sweep measure. X = i, v, t)
	sweepX	(Linear sweep. X = i, v)
	trigXg	(Trigger if measurement \geq value. X = i, v, t)
	trigXI	(Trigger if measurement \leq value. X = i, v, t)
Timing	adelay	(Array delay)
	delay	(Delay)
	disable	(Disable timer)
	enable	(Enable timer)
	rdelay	(Realtime delay)

Table 1. 4200-SCS LPTLIB functions (continued)

GROUP	FUNCTION CALL
GPIB	kibcmd (Send low level GPIB command to instrument)
	kibdefclr (Define string to clear GPIB instrument on devclr)
	kibdefdelete (Delete GPIB definition strings for devclr and devint)
	kibdefint (Define string to clear GPIB instrument on devint)
	kibrvc (Read device dependent string)
	kibsnd (Send device dependent command)
	kibspl (Serial poll an instrument)
	kibsplw (Synchronous serial poll)
RS-232	kspcfg (Configure the port)
	kspnd (Read device dependent string)
	ksprvc (Send device dependent command string)
	kspdefclr (Define string to clear RS-232 instrument on devclr)
	kspdefdelete (Delete RS-232 definition strings for devclr and devint)
	kspdefint (Define string to clear RS-232 instrument on devint)
General	getstatus (Read system and instrument status information)
	setmode (Set operating mode)
	tstdsl (Test station deselect)
	ttsel (Test station select)
Execution*	execut (Executes Devint)
	inshld (Executes No operation)
Arithmetic*	kfpabs (Floating point absolute value)
	kfpadd (Floating point add)
	kfpdiv (Floating point divide)
	kfpexp (Floating point raise e to a power)
	kfplog (Floating point logarithm)
	kfpmul (Floating point multiply)
	kfpneg (Floating point negative value)
	kfppwr (Floating point raise a number to a power)
	kfpsqrt (Floating point square root)
kfpsub (Floating point subtract)	

*Provided for compatibility to other platform versions of LPTLIB.

System Configuration and Diagnostics (KCON)

The Keithley Configuration Utility (KCON) simplifies programming and maintaining a fully integrated test station. KCON provides a single interface for configuring external instruments, switch matrices, and analytical probes, and for executing system diagnostics.

External Instrument Configuration

KCON allows lab managers to integrate external instruments with the 4200-SCS and a supported switch matrix. After the user configures the GPIB addresses for supported instruments Keithley-supplied libraries will function and test modules can be transferred between 4200-SCS systems without any user modification. In addition to the standard supported instruments, the General Purpose Instrument allows users to develop subroutines and control switches for a generic two-terminal or four-terminal instrument. For the widest possible system extensibility, users can develop their own test libraries for general purpose instruments.

Switch Matrix Configuration

Users define the connection of 4200-SCS instruments and external instruments to device under test (DUT) pins through a supported switch matrix configuration. (See Switch Matrix Support and Standard Configurations). Once connections are defined, users need only enter instrument terminal name and pin number to establish connections. The 4200-SCS applications and standard user libraries manage the routing of test signals between instrument terminals and DUT pins. The user doesn't need to remember and program row and column closures. Test modules can transfer between 4200-SCS systems without re-entering connection information.

4200-SCS Instrument Diagnostics

Users can confirm system integrity of SMUs and Remote PreAmps by running a system self-test. For more complex problems, the system's configuration analysis tool can generate reports that assist Keithley's Technical Support staff in diagnosing problems.

Keithley External Control Interface (KXCI)

Keithley External Control Interface provides external GPIB control of the 4200-SCS using a command interface designed for basic compatibility with the 4145B command set of the Hewlett-Packard HP4155/56. The following commands are supported.

- System Mode Commands
DE, CH, VS, VM
SS, VR, IR, VP, IP, VC, IC, SC, HT, DT
SM, WT, IN, NR, DM, XN, YA, YB, XT
MD, ME
SV, GT, DO
RG (defines lowest current range when autoranging, including ranges below 1nA)
- User Mode Commands
US, DV, DI, DS, TV, TI
- Common Mode Commands
IT, DR, BC, ID
RS (defines resolution of returned data up to 6 digits)
MP (allows mapping an SMU to a VS or VM and back to an SMU)

Accessories Supplied

4200-MTRX-2	Ultra Low Noise SMU Triax Cable (Two supplied for each SMU), 2m (6.6ft). Not included with SMUs configured with a 4200-PA Remote PreAmp.
4200-TRX-2	Ultra Low Noise PreAmp Triax Cable, 2m (6.6 ft). Two supplied for Ground Unit. Two supplied in replacement of 4200-MTRX-2 cables for each SMU configured with a 4200-PA.
4200-RPC-2	Remote PreAmp Cable (One supplied for each PreAmp), 2m (6.6 ft).
236-IIC-3	Interlock Cable, 3m (10ft).
Line Cord	NEMA 5-15P for 100-115VAC or CEE 7/7 (Continental European) for 240VAC.
User Manual	Printed User Manual. User Manual and Reference Manual are also supplied on the 4200-SCS Complete Reference CD-ROM.

Optional Instrumentation

4200-SMU	Medium Power Source-Measure Unit for 4200-SCS. 100mA to 100fA, 200V to 1 μ V, 2 Watt
4210-SMU	High Power Source-Measure Unit for 4200-SCS. 1A to 100fA, 200V to 1 μ V, 20Watt
4200-PA	Remote PreAmp Option for 4200-SMU and 4210-SMU, extends SMU to 0.1fA resolution

1.888.KEITHLEY (U.S. only)

www.keithley.com

KEITHLEY

A GREATER MEASURE OF CONFIDENCE

4200-SCS

Semiconductor Characterization System

Support Options

Calibration Options

Return to factory calibration services provide calibration back to factory specifications.

4200-CAL	4200-SCS Return Calibration Service This is a single event return to factory calibration service. Includes calibration back to factory specifications, before and after data reports compliant with ANSI/NCSL Z540-1 and ISO 17025 report requirements. Does not include shipping.
4200-3Y-CAL	4200-SCS 3 Year Return Calibration Service This service provides 3 years of calibrated operation of the 4200-SCS. Includes two calibrations back to factory specifications, before and after data reports compliant with ANSI/NCSL Z540-1 and ISO 17025 report requirements. Does not include shipping.
4200-5Y-CAL	4200-SCS 5 Year Return Calibration Service This service provides 5 years of calibrated operation of the 4200-SCS. Includes four calibrations back to factory specifications, before and after data reports compliant with ANSI/NCSL Z540-1 and ISO 17025 report requirements. Does not include shipping.

Repair Options

4200-REPAIR	4200-SCS Repair Service Contact the factory for repair estimates.
4200-3Y-REPAIR	4200-SCS 3 Year Hardware Warranty Extension This service includes 3 years of return to factory repairs from date of shipment (including the standard product warranty) and return shipping. If an instrument proves defective in parts or workmanship, Keithley will repair and calibrate or replace the 4200-SCS and return it, shipping prepaid. Must be ordered at the same time as the 4200-SCS. (Rush shipping available with additional charges.)
4200-5Y-REPAIR	4200-SCS 5 Year Hardware Warranty Extension This service includes 5 years of return to factory repairs from date of shipment (including the standard product warranty) and return shipping. If an instrument proves defective in parts or workmanship, Keithley will repair and calibrate or replace the 4200-SCS and return it, shipping prepaid. Must be ordered at the same time as the 4200-SCS. (Rush shipping available with additional charges.)

Instrumentation Upgrades

4200-UPGRADE	4200-SCS Hardware Upgrade Service Includes installation of new instruments, calibration and verification. This item must be included, in addition to the price of any instruments purchased, when a system is returned to the factory for an instrumentation upgrade (adding SMUs or PreAmps). This fee is charged only once for an upgrade event. The customer may add any quantity or type of instrument to their system for the upgrade fee. The service fee includes a system burn-in and calibration. This service fee does not apply to software upgrades or Model 4200-CPU-2G/C and 4200-CPU-2G/F upgrades. Does not include shipping.
4200KTEI-5.0	4200-SCS Keithley Test Environment Interactive (KTEI) software test suite version 5.0; includes KTEIV5.0 CD and Complete Reference V5.0 CD.
4200-CPU-2G/C	4200-SCS upgrade service; includes installation of new 2GHz single board computer (w/512MB SDRAM, 100-BaseT network port, ATI M6 graphics controller), three USB 1.1 ports (two front, one back), fresh installation of Windows XP Professional operating system (not upgrade—See Note). Also includes installation of Model 4200KTEI-5.0 software test suite (for 4200-SCS/C (CRT) systems only).
4200-CPU-2G/F	Same as 4200-CPU-2G/C except for 4200-SCS/F (Flat Panel) systems only.

Note: The 4200-CPU-2G/C and -F upgrades restore the 4200-SCS to factory conditions. The hard drive is reformatted and all old data and projects will NOT be preserved. Be sure to back up all data and projects prior to ordering either of these upgrades.

Approved Third-Party Software:

Adobe Acrobat Reader 4.0 or later
Adobe Acrobat 4.0 or later
Diskeeper 5.0 or later
Microsoft Excel
Microsoft Word
Full Armor 5.5 or later
Internet Explorer 5.0 or later
Norton AntiVirus 2000 6.0 or later
Visual C++ .net
Windows NT 4.0 & service pack 6a OR Windows XP Professional
McAfee VirusScan 7.0 or later
Symantec pcAnywhere 11.0
Novell Client Services

1.888.KEITHLEY (U.S. only)

www.keithley.com

KEITHLEY

A GREATER MEASURE OF CONFIDENCE

4200-SCS

Semiconductor Characterization System

Warranty Summary

This section summarizes the warranties of the 4200-SCS. For complete warranty information, refer to the 4200-SCS Reference Manual. Any portion of the product which is not manufactured by Keithley is not covered by this warranty and Keithley will have no duty to enforce any other manufacturer's warranties.

Hardware Warranty

Keithley Instruments, Inc. warrants the Keithley manufactured portion of the hardware for a period of one year from defects in materials or workmanship; provided that such defect has not been caused by use of the Keithley hardware which is not in accordance with the hardware instructions. The warranty does not apply upon any modification of Keithley hardware made by the customer or operation of the hardware outside the environmental specifications.

Software Warranty

Keithley warrants for the Keithley produced portion of the software or firmware will conform in all material respects with the published specifications for a period of ninety (90) days; provided the software is used on the product for which it is intended in accordance with the software instructions. Keithley does not warrant that operation of the software will be uninterrupted or error-free, or that the software will be adequate for the customer's intended application. The warranty does not apply upon any modification of the software made by the customer.

Embedded PC Policy

Caution: Keithley Instruments warrants the performance of the Model 4200-SCS only with the factory-approved Windows Operating system and applications software preinstalled on the 4200-SCS by Keithley Instruments. Systems that have been modified by the addition of un-approved third-party application software (software that is not explicitly approved and supported by Keithley Instruments) are not covered under the product warranty. Model 4200-SCS systems with unapproved software may need to be restored to factory approved condition before any warranty service can be performed (e.g., calibration, upgrade, technical support). Services provided by Keithley Instruments to restore systems to factory approved condition will be treated as out-of-warranty services with associated time and material charges. Approved software is listed under "Approved Third-Party Software." The Model 4200-SCS can safely use this third-party software.

CAUTION: DO NOT reinstall or upgrade the Windows operating system (OS) on any Model 4200-SCS. This action should only be performed at an authorized Keithley service facility. Violation of this precaution will void the Model 4200-SCS warranty and may render the Model 4200-SCS unusable. Any attempt to reinstall or upgrade the Windows operating system will require a return-to-factory repair and will be treated as an out-of-warranty service, including time and material charges.

Optional Accessories

Computer Options

4200-CRT	17" SVGA Color Monitor
4200-MOUSE	Microsoft Ambidextrous 2 Button Mouse (Note: a pointing device is integrated with the 4200 keyboard.)
4200-FPD-RM	Rack mounted 1U, 17" FPD with keyboard and trackball (See photo on back cover)

Remote PreAmp Mounting Accessories

4200-MAG-BASE	Magnetic base for mounting 4200-PA on a prober platen
4200-VAC-BASE	Vacuum base for mounting 4200-PA on a prober platen
4200-TMB	Triaxial mounting bracket for mounting 4200-PA on a triaxial mounting panel

Other Accessories

4200-MAN	Printed Manual set for 4200-SCS (Manual on CD-ROM is included in Base Unit)
4200-CART	Roll-around cart for 4200-SCS
Model 8006	Component Test Fixture
Model 8007	Semiconductor Test Fixture

C-V Options

4200-590	Model 590/100k/1M C-V Analyzer with IEEE-488 Interface, 1m IEEE cable, 2 ea. BNC-Triaxial Adapters
Model 5909	Calibration Sources for Model 590 C-V Analyzer

1.888.KEITHLEY (U.S. only)

www.keithley.com

KEITHLEY

A GREATER MEASURE OF CONFIDENCE

Switch Matrix Options

Overview

A number of useful standard switch matrix configurations are available for 4200-SCS. Each standard configuration includes all components, cabling, and instructions for the user to assemble the switch matrix and add the matrix configuration to the 4200-SCS test environment. Once a supported configuration is added to the test environment, the 4200-SCS standard user library (matrixulib) connects instrument terminals to output pins through a simple “fill-in-the-blank” interface.

Ultra-Low Current/Local Sense Configuration (4200-UL-LS-XX)

The Ultra-Low Current/Local Sense switch configuration is built using the Keithley Model 7174A Low Current Matrix Card, which is designed for semiconductor research, development and production applications requiring high quality, high performance switching of I-V and C-V signals. This configuration provides eight instrument inputs with up to 72 output pins at only 10fA typical offset current.

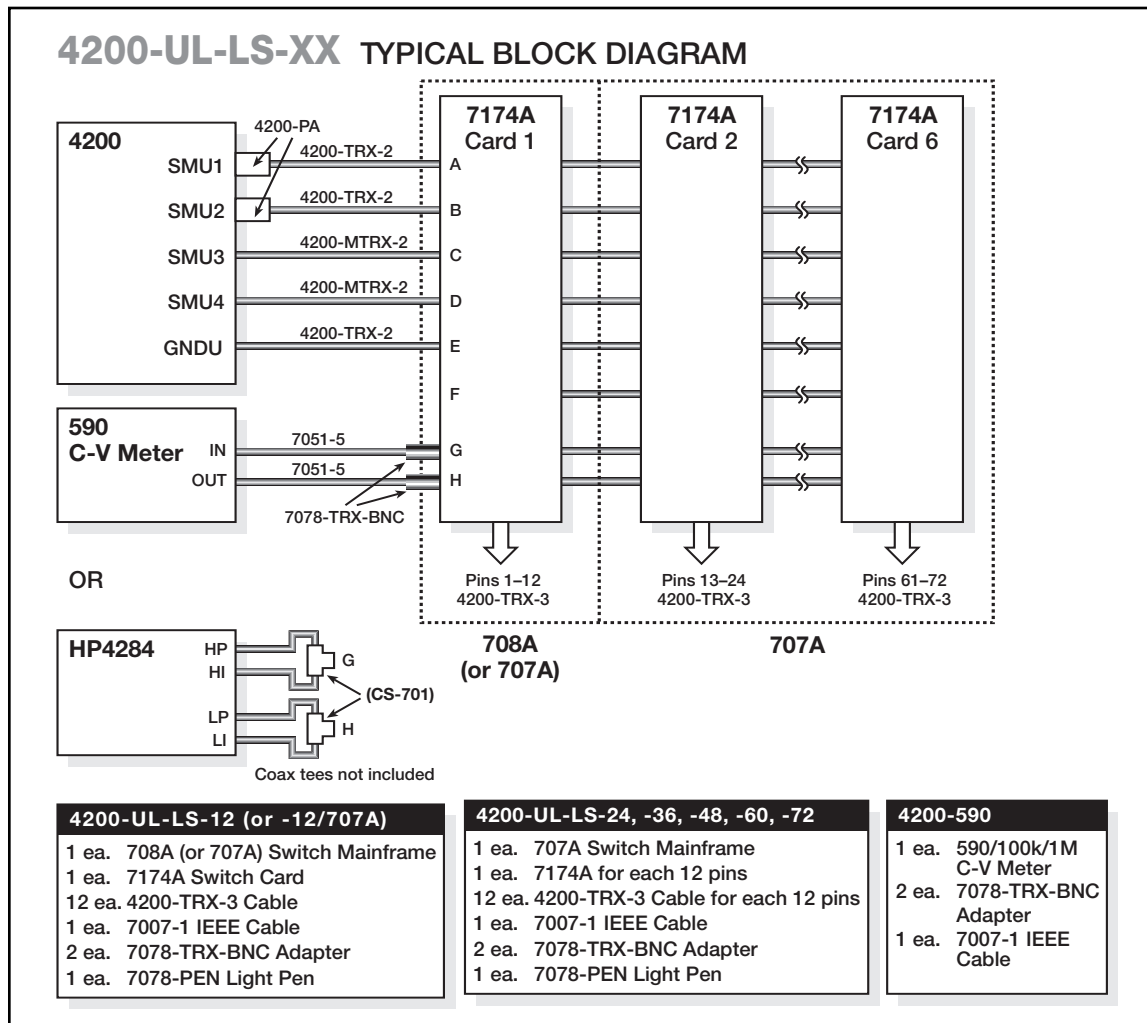

Connector Type: 3-lug Triax
Maximum Signal Level: 200V, 2A
Offset Current: 100fA max, 10fA typical

Maximum Leakage: 0.01pA/V
3dB Bandwidth: 30MHz typical

1.888.KEITHLEY (U.S. only)

www.keithley.com

KEITHLEY

A GREATER MEASURE OF CONFIDENCE

Semiconductor Characterization System

Ultra-Low Current/Remote Sense Configuration (4200-UL-RS-XX)

Remote sensing is more accurate for voltage sourcing and measuring, particularly at currents greater than approximately 10mA, but degrades the performance of C-V meters and pulse generators. The Ultra-Low Current/Remote Sense switch configuration is built using the Keithley Model 7174A Low Current Matrix Card, which is designed for semiconductor research, development and production applications requiring high quality, high performance switching of I-V and C-V signals. The configuration provides six instrument inputs with up to 30 output pins at only 10fA typical offset current.

4200-UL-RS-XX TYPICAL BLOCK DIAGRAM

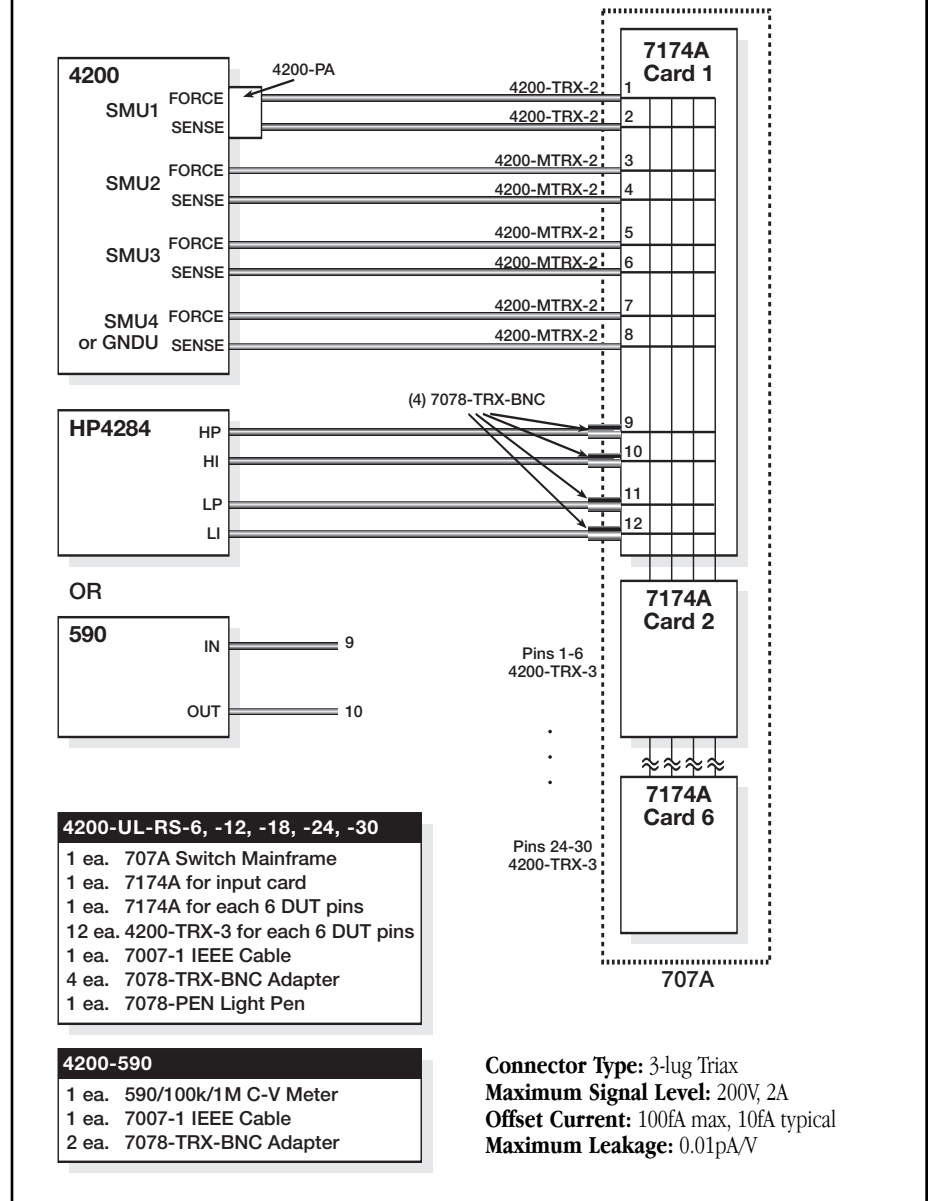

1.888.KEITHLEY (U.S. only)

www.keithley.com

KEITHLEY

A GREATER MEASURE OF CONFIDENCE

4200-SCS

Semiconductor Characterization System

Low Current/Local Sense Configuration (4200-LC-LS-XX)

The Low Current/Local Sense switch configuration is built using the Keithley Model 7072 Semiconductor Matrix Card, which is designed for semiconductor applications requiring good quality of I-V and C-V signals. The configuration provides eight instrument inputs with up to 72 output pins with less than 1pA offset current.

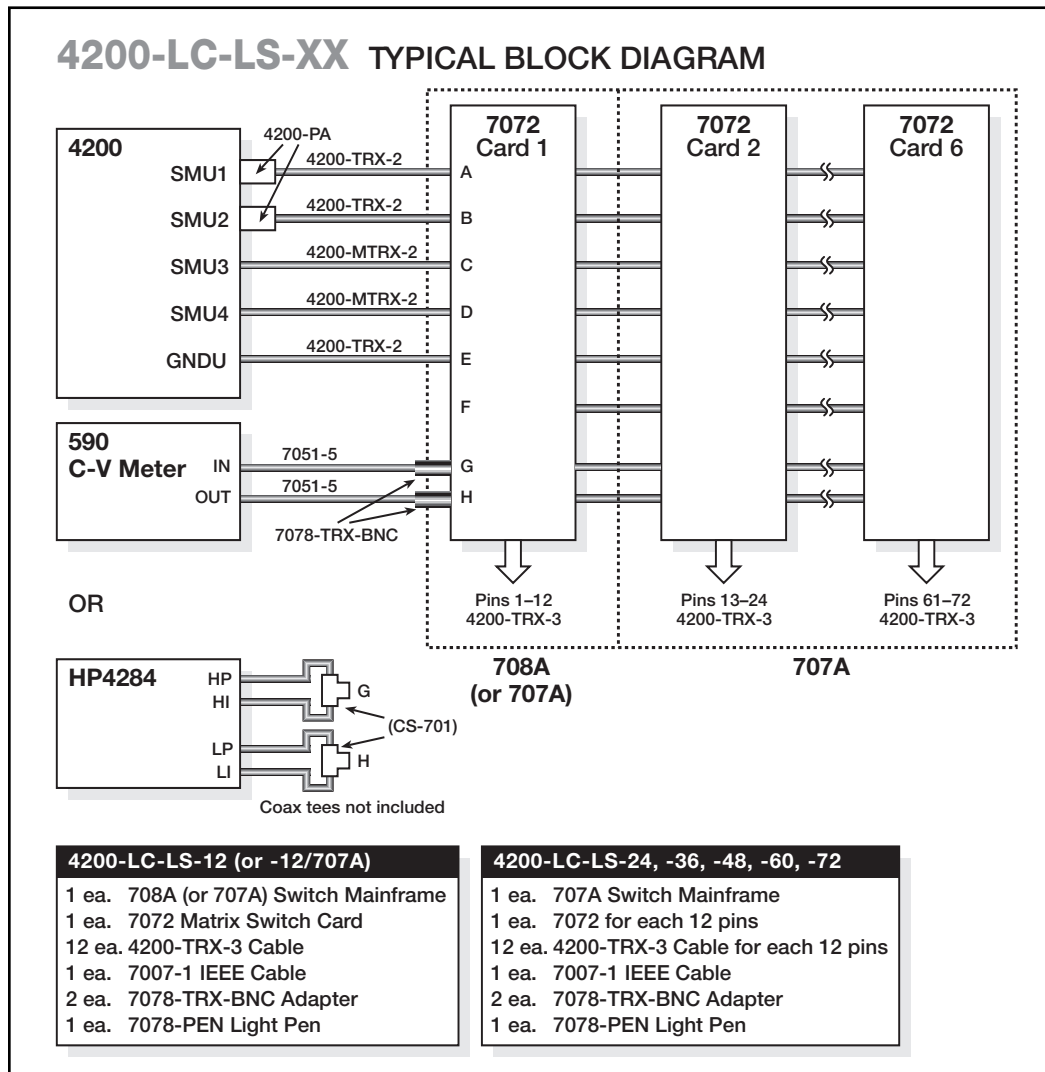

Connector Type: 3-lug triax
Maximum Signal Level: 200V, 1A
Offset Current: <1pA (Rows A - B)
Maximum Leakage: 0.1pA/V
3dB Bandwidth: 5MHz typical (Rows G - H)

1.888.KEITHLEY (U.S. only)

www.keithley.com

KEITHLEY

A GREATER MEASURE OF CONFIDENCE

Semiconductor Characterization System

General-Purpose/Remote Sense Configuration (4200-GP-RS-XX)

The General-Purpose/Remote Sense switch configuration is built using the Keithley Model 7071 General-Purpose Matrix Card, which is designed for applications requiring cost-effective switching of I-V and C-V signals. Remote sensing is more accurate for voltage sourcing and measuring, particularly at currents greater than approximately 10mA. The configuration provides eight instrument inputs with up to 72 output pins with less than 100pA offset current. Each crosspoint provides HI, LO, and GUARD signal switching.

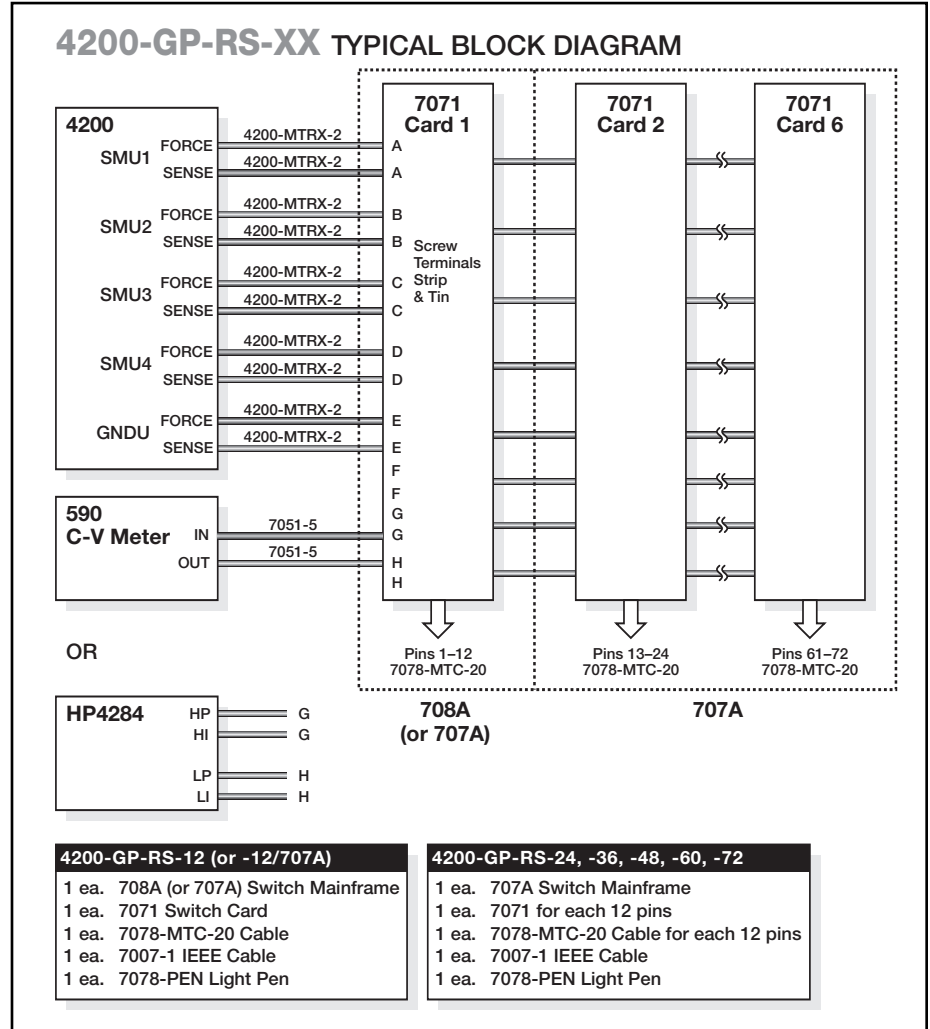

Maximum Signal Level: 200V, 1A

Offset Current: <100pA

Maximum Leakage: 100pA/V

3dB Bandwidth: 5MHz typical

Connector Type: Quick disconnect using 38-pin connectors or screw terminals.

1.888.KEITHLEY (U.S. only)

www.keithley.com

KEITHLEY

A GREATER MEASURE OF CONFIDENCE

Cabinets and Mounting Accessories

4200-CAB-20UX	20U Cabinet (35 in.)
4200-CAB-25UX	25U Cabinet (44 in.)
4200-CAB-34UX	34U Cabinet (60 in.)
4200-RM	Slide Rack Mounting Kit for 4200-SCS/F and 4200-SCS/C
4200-CRT-RM	Fixed Rack Mounting Kit for 4200-CRT
4200-KEY-RM	Slide Rack Mounting Kit for standard keyboard and pointing device
4200-FPD-RM	Rack mounted 1U, 17" FPD with keyboard and trackball (See photo on back cover)
Model 2288-1G	Model 590 Rack Mount Kit

Additional Cables and Connectors¹

4200-RPC-0.3	Remote PreAmp Cable, 0.3m (for use inside prober shield)
4200-RPC-2	Remote PreAmp Cable, 2m (for remote location of 4200-PA, one included with each 4200-PA)
4200-RPC-3	Remote PreAmp Cable, 3m (for remote location of 4200-PA)
4200-RPC-6	Remote PreAmp Cable, 6m (for remote location of 4200-PA)
4200-TRX-0.3	Ultra Low Noise PreAmp Triax Cable, 0.3m, (Triax-Triax, connects 4200-PA to a test fixture, recommended for remote location of the 4200-PA)
4200-TRX-1	Ultra Low Noise PreAmp Triax Cable, 1m, (Triax-Triax, connects 4200-PA to a test fixture)
4200-TRX-2	Ultra Low Noise PreAmp Triax Cable, 2m, (Triax-Triax, connects 4200-PA to a test fixture, two included with each 4200-PA)
4200-TRX-3	Ultra Low Noise PreAmp Triax Cable, 3m, (Triax-Triax, connects 4200-PA to a test fixture)
4200-MTRX-1	Ultra Low Noise SMU Triax Cable, 1m (Mini Triax-Triax, connects 4200 SMUs to a test fixture)
4200-MTRX-2	Ultra Low Noise SMU Triax Cable, 2m (Mini Triax-Triax, connects 4200 SMUs to a test fixture, two included with each 4200 SMU that is not configured with a Remote PreAmp)
4200-MTRX-3	Ultra Low Noise SMU Triax Cable, 3m (Mini Triax-Triax, connects 4200 SMUs to a test fixture)
236-ILC-3	Interlock Cable, 3m (one included with each 4200-SCS)
7007-1	Shielded IEEE-488 Cable (1m)
7007-2	Shielded IEEE-488 Cable (2m)
7078-TRX-BNC	Coaxial connector for connecting coax instruments to a triax matrix

¹ All 4200-SCS systems and instrument options are supplied with required cables (2m length).

4200-SCS

Semiconductor Characterization System

Front and Rear Panel Photographs



The 4200-SCS is designed for rack mounting. It has the same dimensions and occupies the same rack space as semiconductor parametric analyzers that may already be in use. The 4200-SCS/C (Composite Front Bezel) eliminates the flat panel display for users planning to use an external CRT exclusively. Excellent for use with the 4200-FPD-RM rack mount display with keyboard.

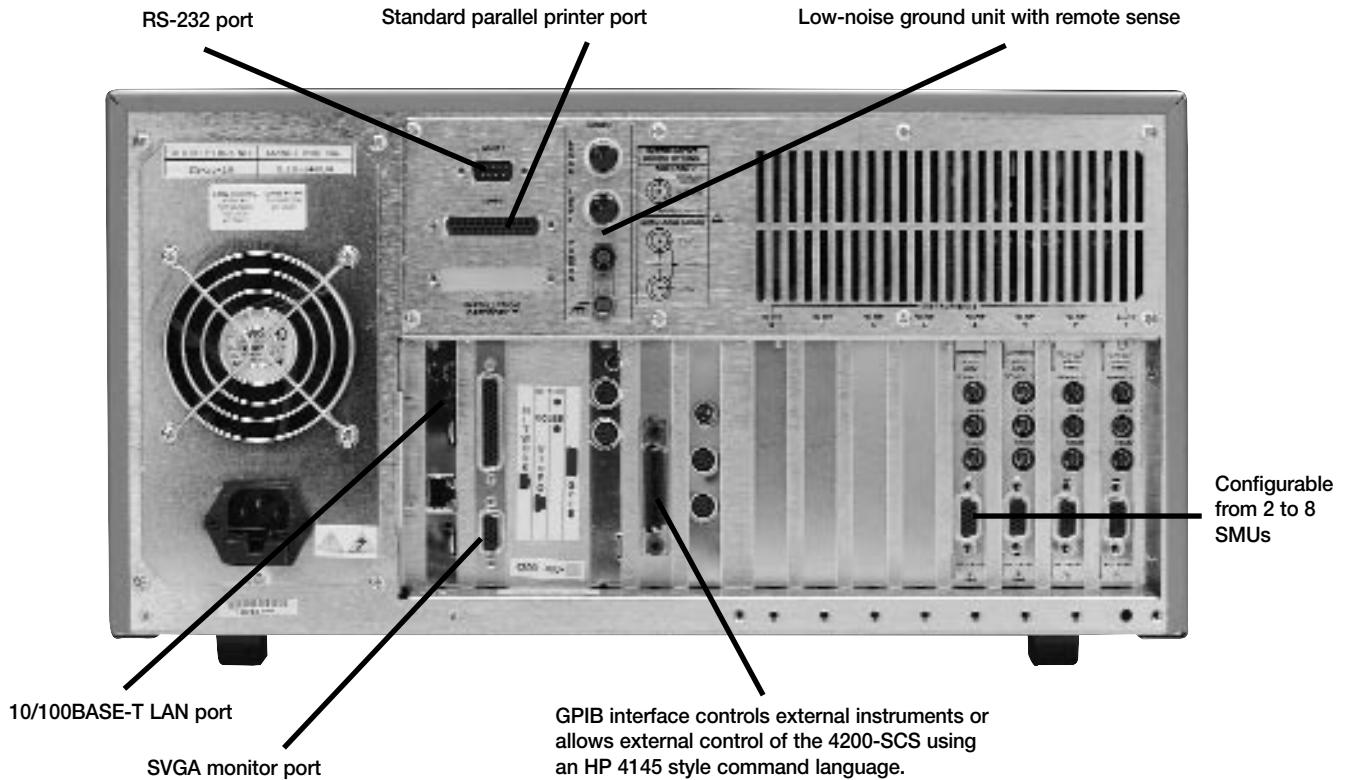

1.888.KEITHLEY (U.S. only)

www.keithley.com

KEITHLEY

A GREATER MEASURE OF CONFIDENCE

4200-SCS

Semiconductor Characterization System

PreAmp Mounting and Cabling

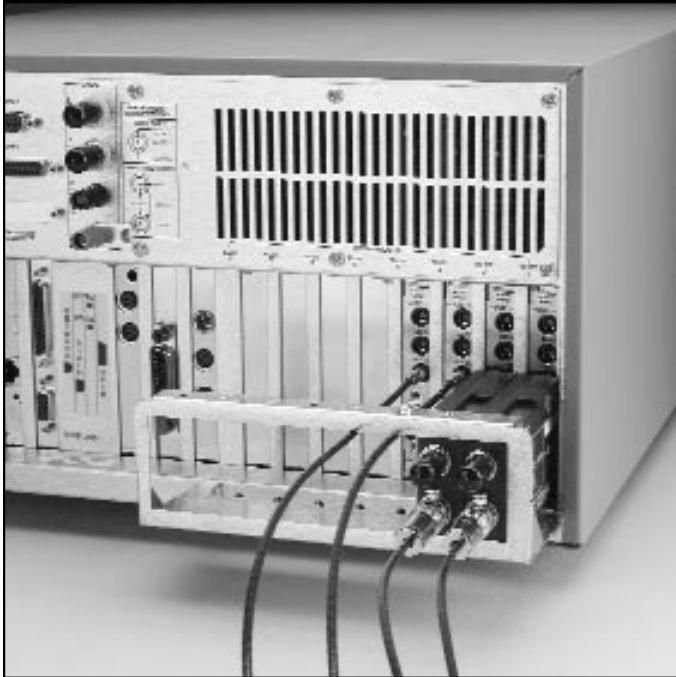

PreAmps ship factory installed for local operation in numerical order, i.e., SMU1, SMU2, SMU3... up to the number of PreAmps specified.

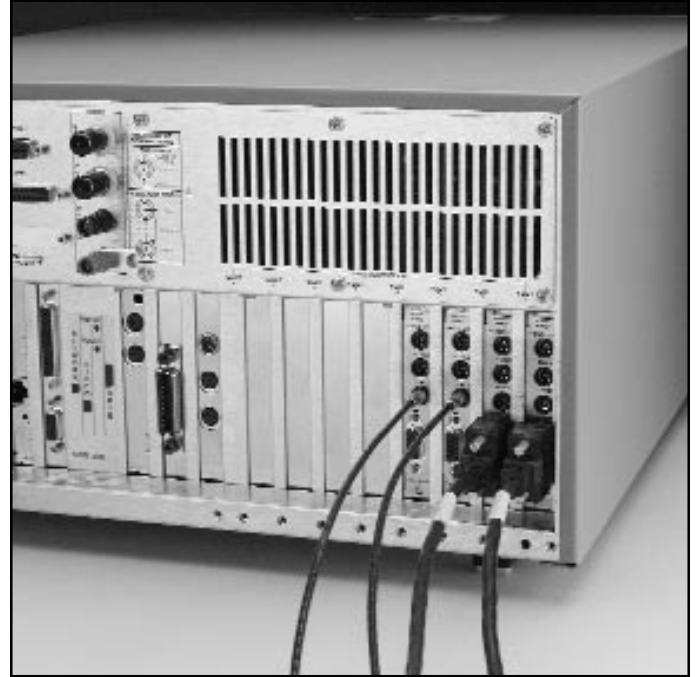

Remote PreAmp Cables (4200-RPC) provide analog signal paths and digital control when the 4200-PA is placed in a remote location.



An optional vacuum (Model 4200-VAC-BASE) or magnetic (Model 4200-MAG-BASE) platen mounting base allows the PreAmp to be located next to manipulators on the chuck platen, eliminating measurement problems caused by long cable lengths when performing ultra-low current measurements.

If platen space is not available, the triax mounting bracket (Model 4200-TMB) allows users to locate the PreAmp on dual triaxial connectors that may already be installed for HP4156 Kelvin triax cables. This mounting option reduces problems caused by long cables without occupying platen space.

1.888.KEITHLEY (U.S. only)

www.keithley.com

KEITHLEY

A GREATER MEASURE OF CONFIDENCE

4200-SCS

Semiconductor Characterization System

4200-SCS Accessories



Model 4200-CART
Roll-Around Cart for 4200-SCS

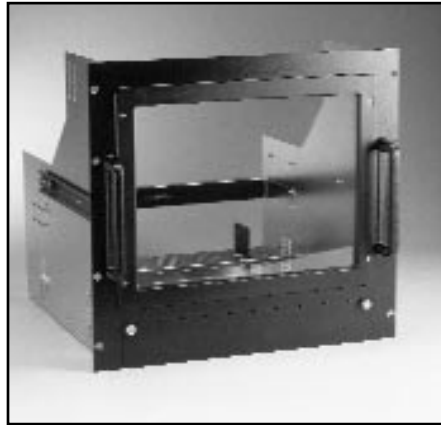

Model 4200-CRT-RM
The CRT rack mount accepts up to 17 inch monitors.



Model 4200-KEY-RM
Keyboard Rack Mount



Model 4200-FPD-RM
17" high resolution TFT display with keyboard and trackball pointing device in a 1U high slide rack mounting kit. Complete with cables and accessories to connect directly to the Model 4200-SCS. Note: Unit is not CE marked for sale in EEC countries.

Specifications are subject to change without notice.
All Keithley trademarks and trade names are the property of Keithley Instruments, Inc.
All other trademarks and trade names are the property of their respective companies.



A GREATER MEASURE OF CONFIDENCE

Keithley Instruments, Inc.

Corporate Headquarters • 28775 Aurora Road • Cleveland, Ohio 44139 • 440-248-0400 • Fax: 440-248-6168 • 1-888-KEITHLEY (534-8453) • www.keithley.com

Belgium: Sint-Pieters-Leeuw • 02-363 00 40 • Fax: 02-363 00 64 • www.keithley.nl

China: Beijing • 8610-82251886 • Fax: 8610-82251892 • www.keithley.com.cn

Finland: Helsinki • 09-5306-6560 • Fax: 09-5306-6565 • www.keithley.com

France: Palaiseau Cédex • 01-64 53 20 20 • Fax: 01-60 11 77 26 • www.keithley.fr

Germany: Germering • 089/84 93 07-40 • Fax: 089/84 93 07-34 • www.keithley.de

Great Britain: Theale • 0118 929 7500 • Fax: 0118 929 7519 • www.keithley.co.uk

India: Bangalore • 080 212 8027 • Fax : 080 212 8005 • www.keithley.com

Taiwan: Hsinchu • 886-3-572-9077 • Fax: 886-3-572-9031 • www.keithley.com.tw

Italy: Milano • 02-48 39 16 01 • Fax: 02-48 30 22 74 • www.keithley.it

Japan: Tokyo • 81-3-5733-7555 • Fax: 81-3-5733-7556 • www.keithley.jp

Korea: Seoul • 82-2-574-7778 • Fax: 82-2-574-7838 • www.keithley.com

Netherlands: Gorinchem • 0183-635333 • Fax: 0183-630821 • www.keithley.nl

Singapore: Singapore • 65-6747-9077 • Fax: 65-6747-2991 • www.keithley.com

Sweden: Solna • 08-509 04 600 • Fax: 08-655 26 10 • www.keithley.com

Switzerland: Zurich • 01-821 94 44 • Fax: 01-820 30 81 • www.keithley.ch